

SUB-CIRCUIT DIAGRAMS

Selected Block (p. 2)

1990 Ford Taurus

For <http://www.mitchell.narod.ru/>

Copyright © 1997 Mitchell International

Friday, March 02, 2001 02:14PM

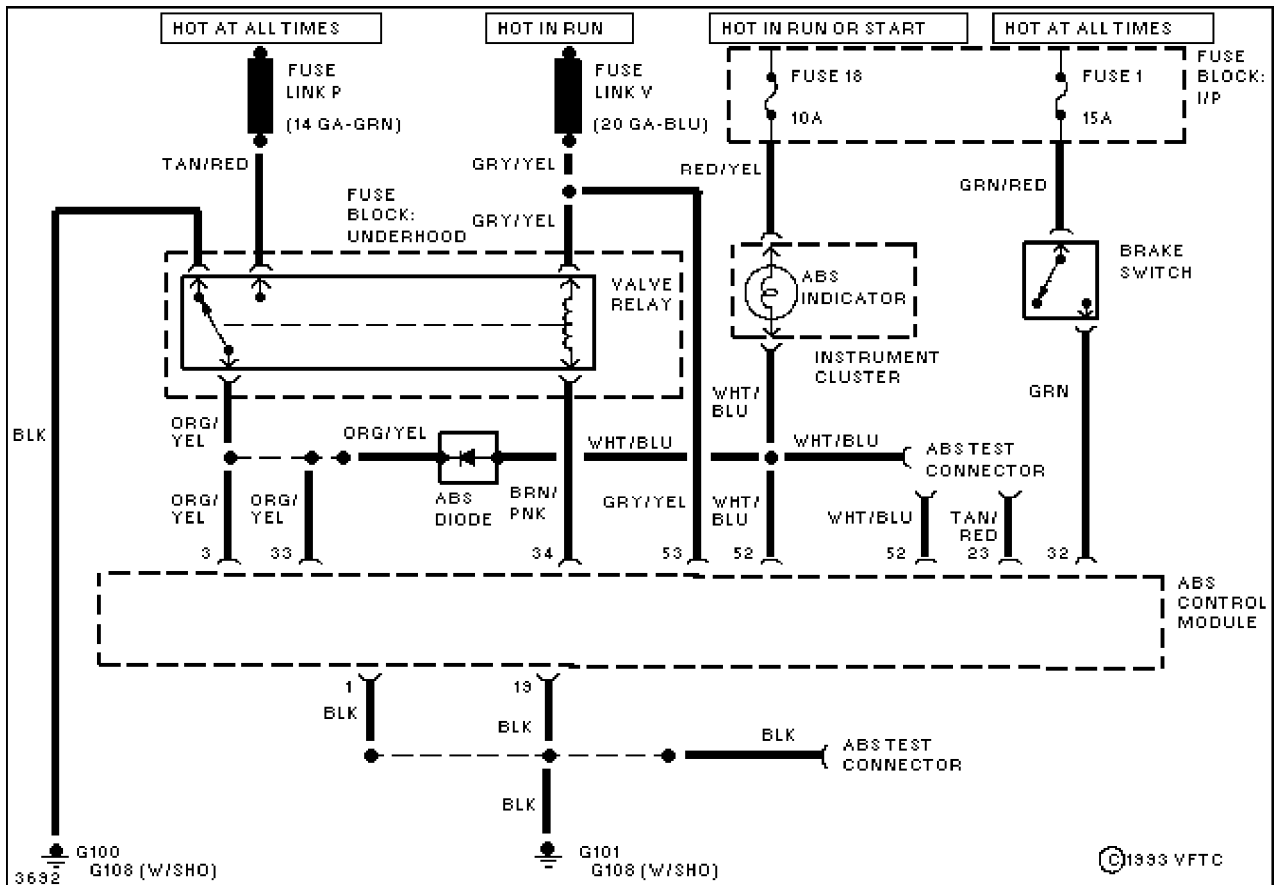

Fig. 13: Anti-Lock Brakes - Power Circuit

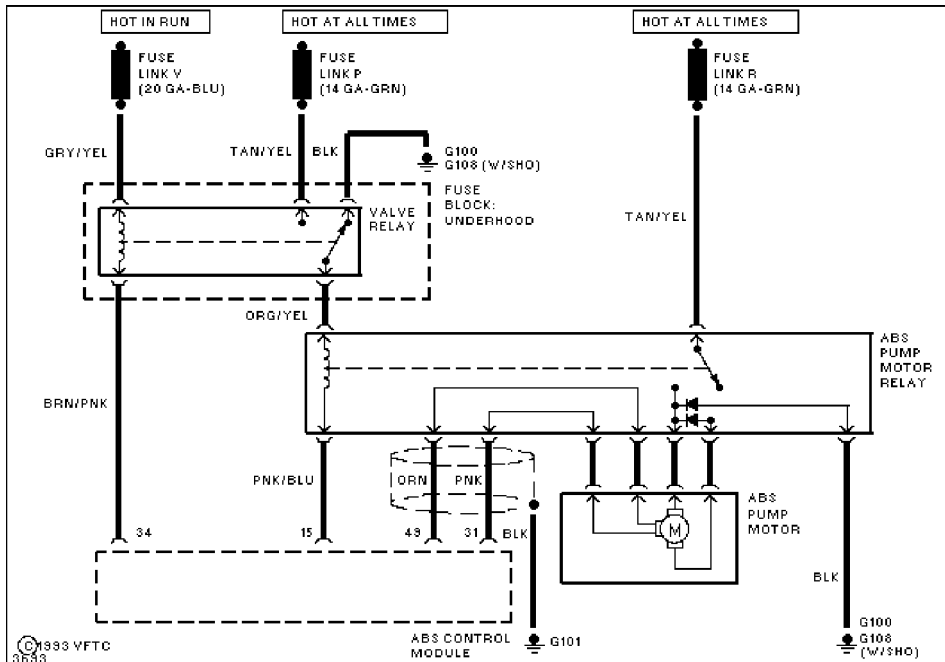

Fig. 14: Anti-Lock Brakes - Pump Circuit

SUB-CIRCUIT DIAGRAMS
Selected Block (p. 3)
 1990 Ford Taurus
 For <http://www.mitchell.narod.ru/>
 Copyright © 1997 Mitchell International
 Friday, March 02, 2001 02:14PM

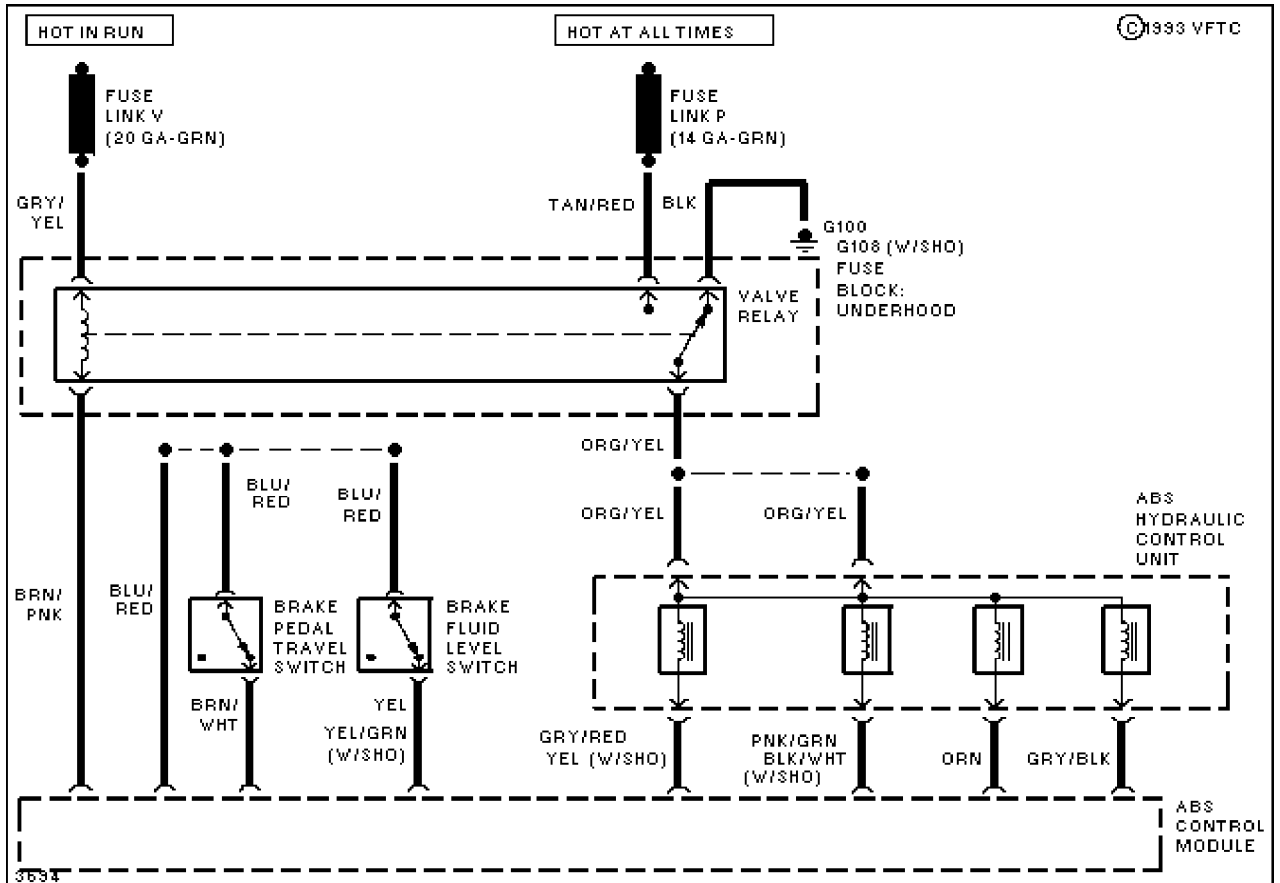

Fig. 15: Anti-Lock Brakes - Rear Valve Circuit

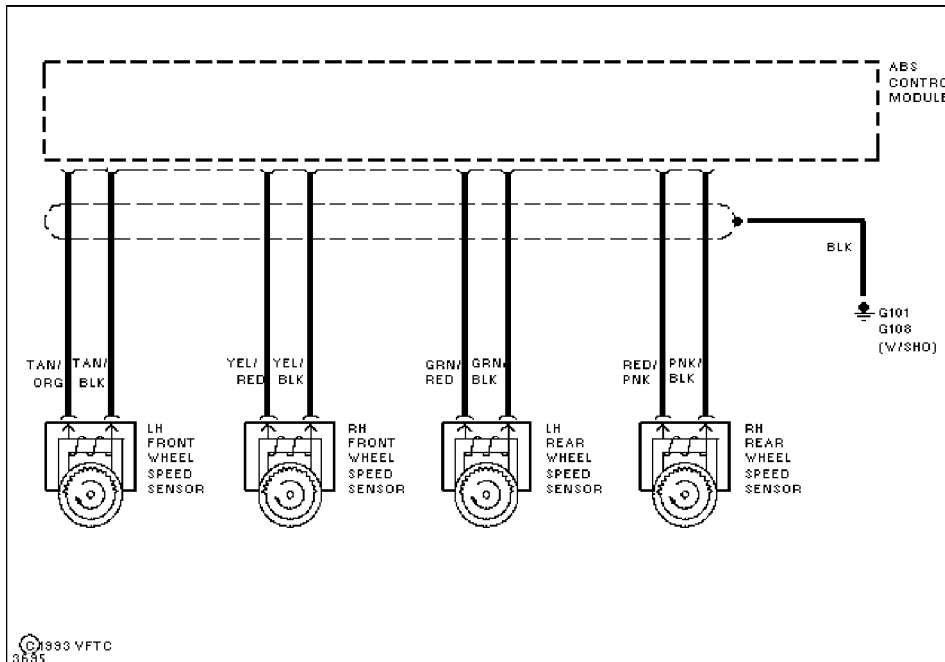

Fig. 16: Anti-Lock Brakes - Wheel Speed Sensor Circuit

SUB-CIRCUIT DIAGRAMS

Selected Block (p. 4)

1990 Ford Taurus

For <http://www.mitchell.narod.ru/>

Copyright © 1997 Mitchell International

Friday, March 02, 2001 02:14PM

COOLING FANS

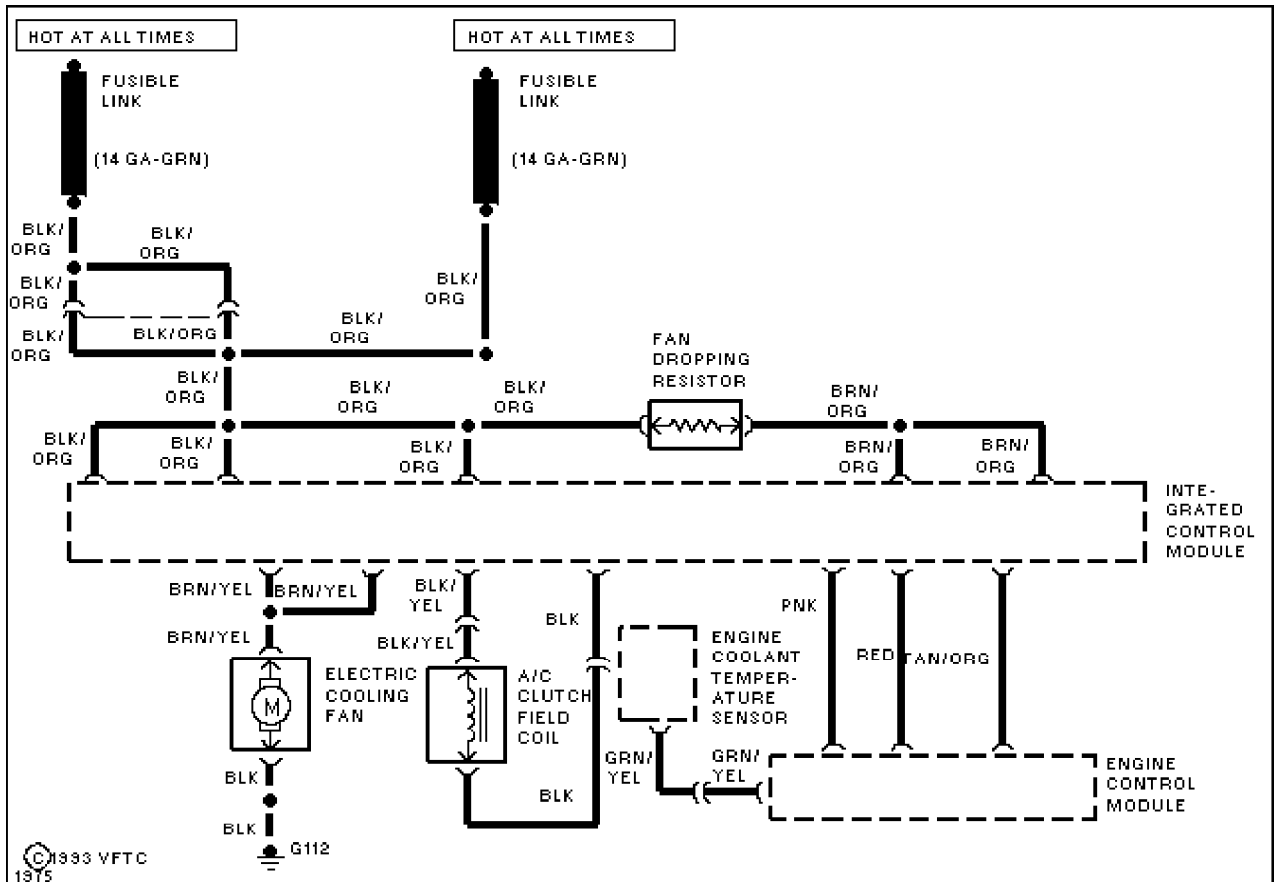

Fig. 17: Cooling Fan Circuit (2.5L)

SUB-CIRCUIT DIAGRAMS
Selected Block (p. 5)
 1990 Ford Taurus
 For <http://www.mitchell.narod.ru/>
 Copyright © 1997 Mitchell International
 Friday, March 02, 2001 02:14PM

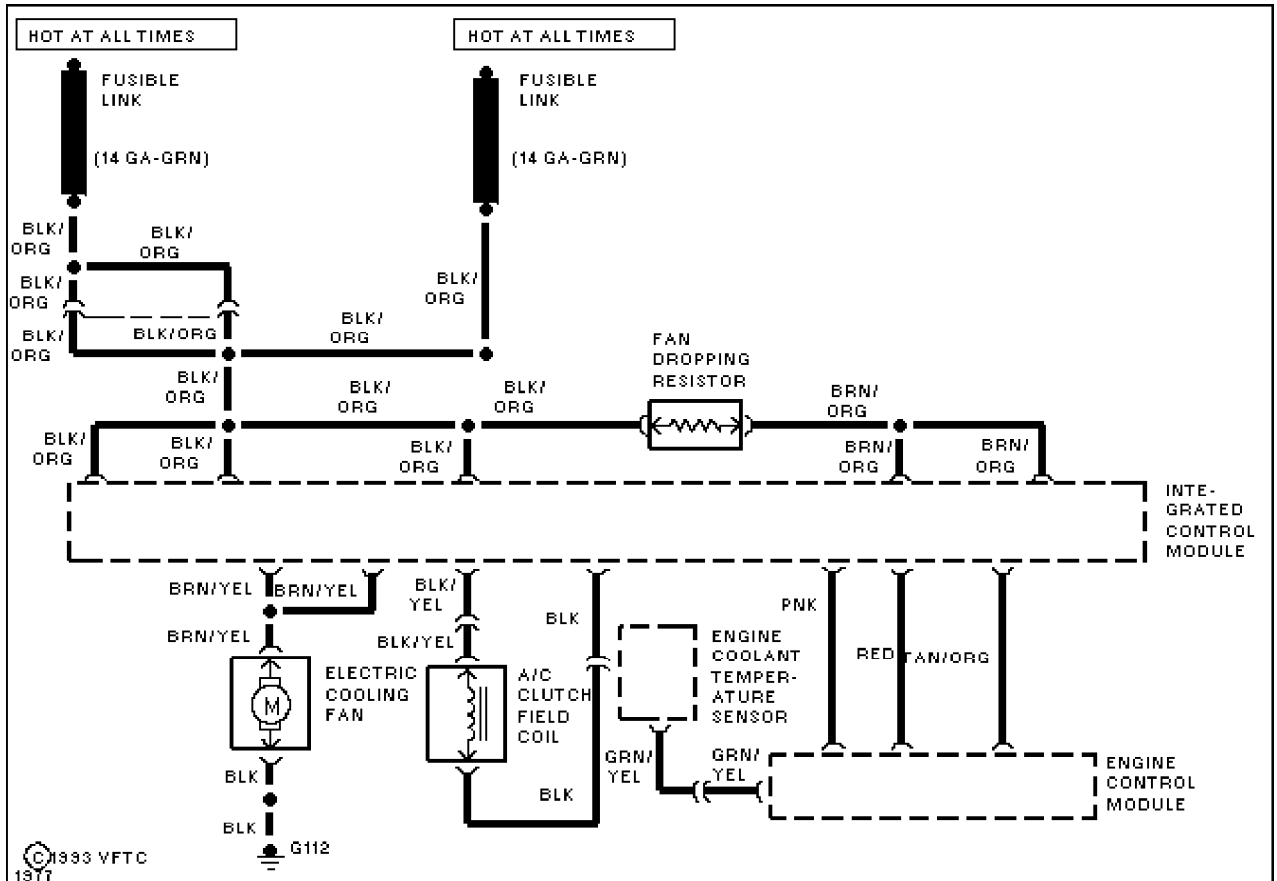

Fig. 18: Cooling Fan Circuit (3.0L Except SHO)

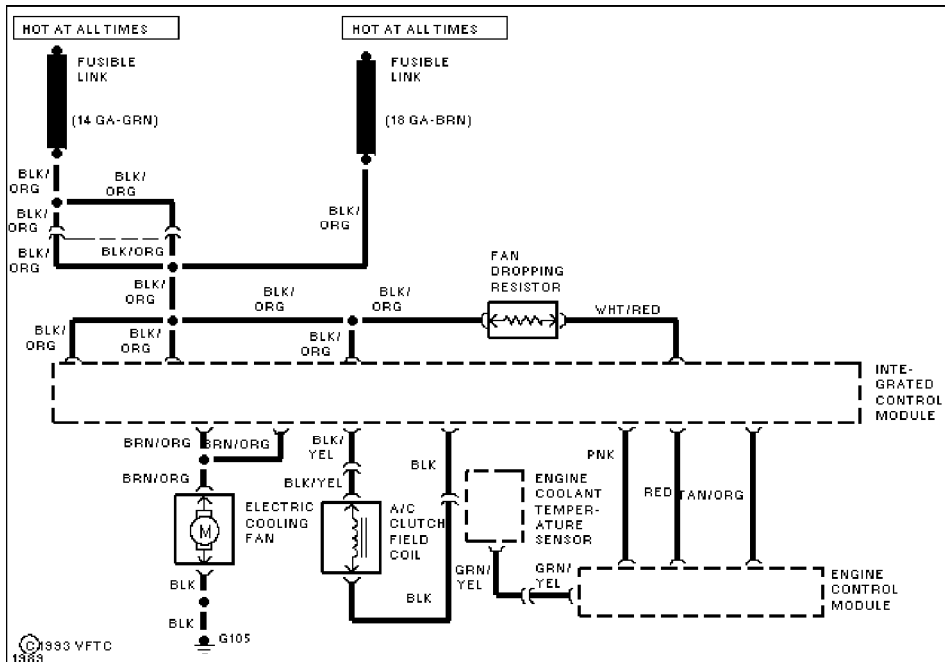

Fig. 19: Cooling Fan Circuit (3.0L SHO)

SUB-CIRCUIT DIAGRAMS

Selected Block (p. 6)

1990 Ford Taurus

For <http://www.mitchell.narod.ru/>

Copyright © 1997 Mitchell International

Friday, March 02, 2001 02:14PM

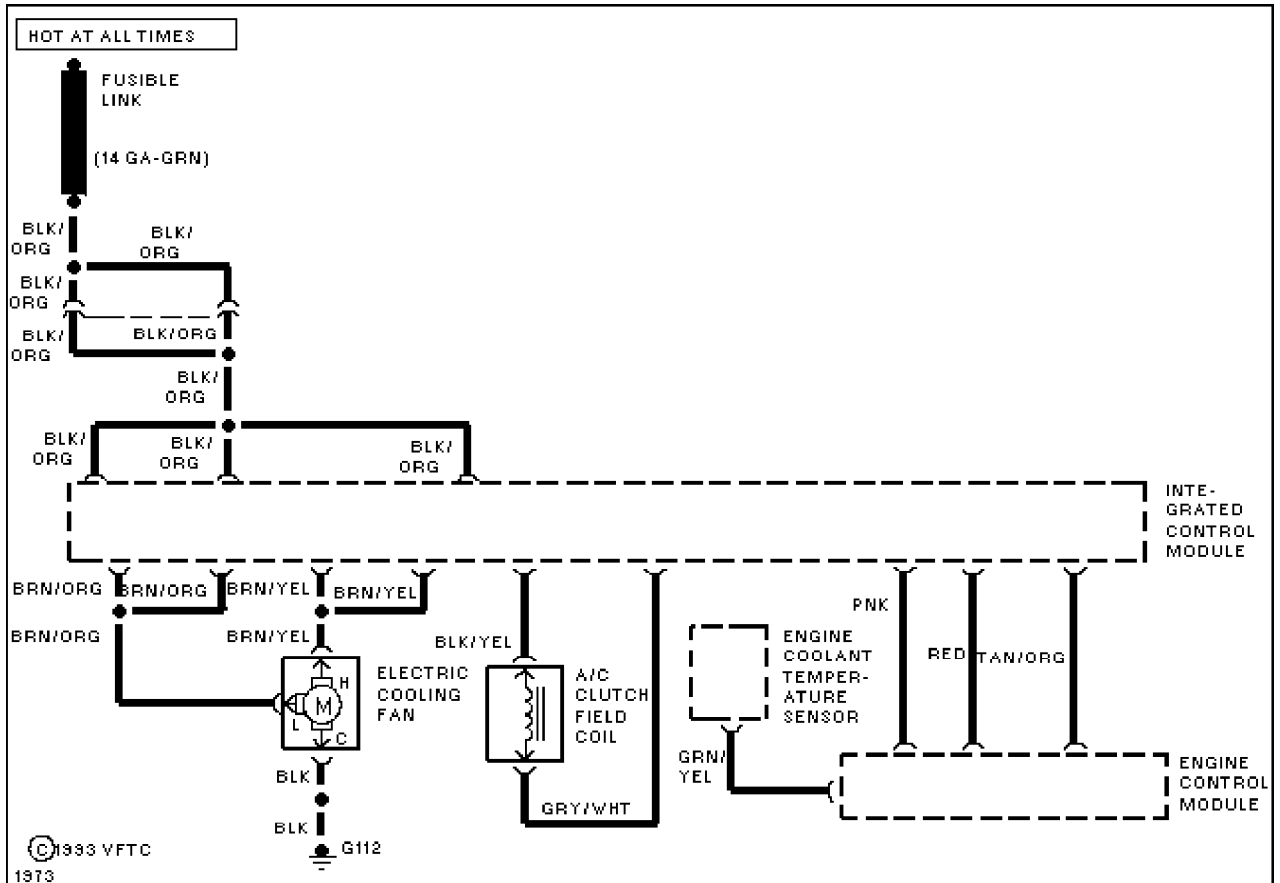

Fig. 20: Cooling Fan Circuit (3.8L)