

WIRING DIAGRAMS
Selected Block
 1993 Ford Taurus
 For <http://www.mitchell.narod.ru/>
 Copyright © 1997 Mitchell International
 Friday, March 02, 2001 02:30PM

POWER SEATS

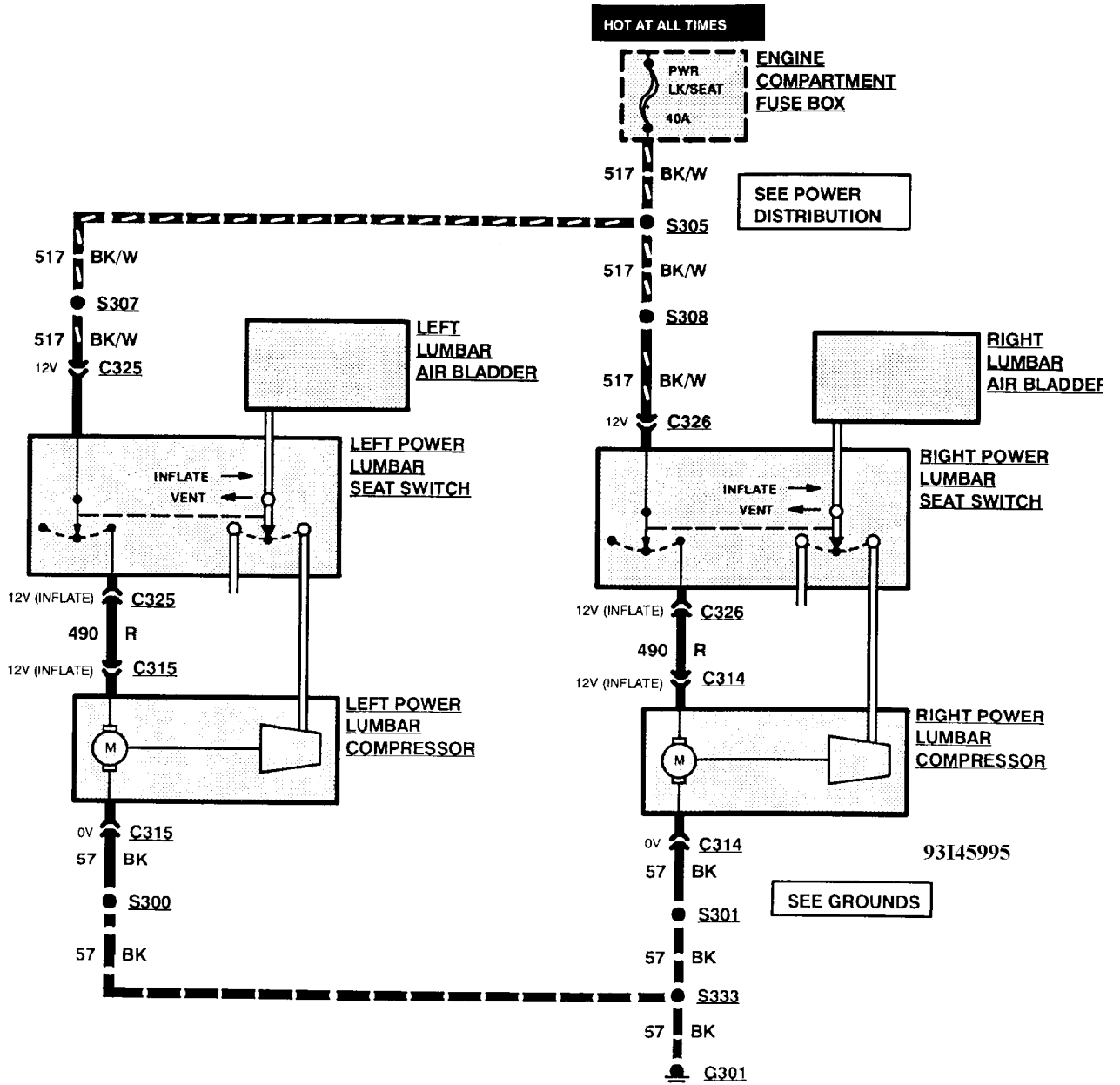

Fig. 78: Lumbar Seat Wiring Diagram

WIRING DIAGRAMS

Selected Block (p. 2)

1993 Ford Taurus

For <http://www.mitchell.narod.ru/>

Copyright © 1997 Mitchell International

Friday, March 02, 2001 02:30PM

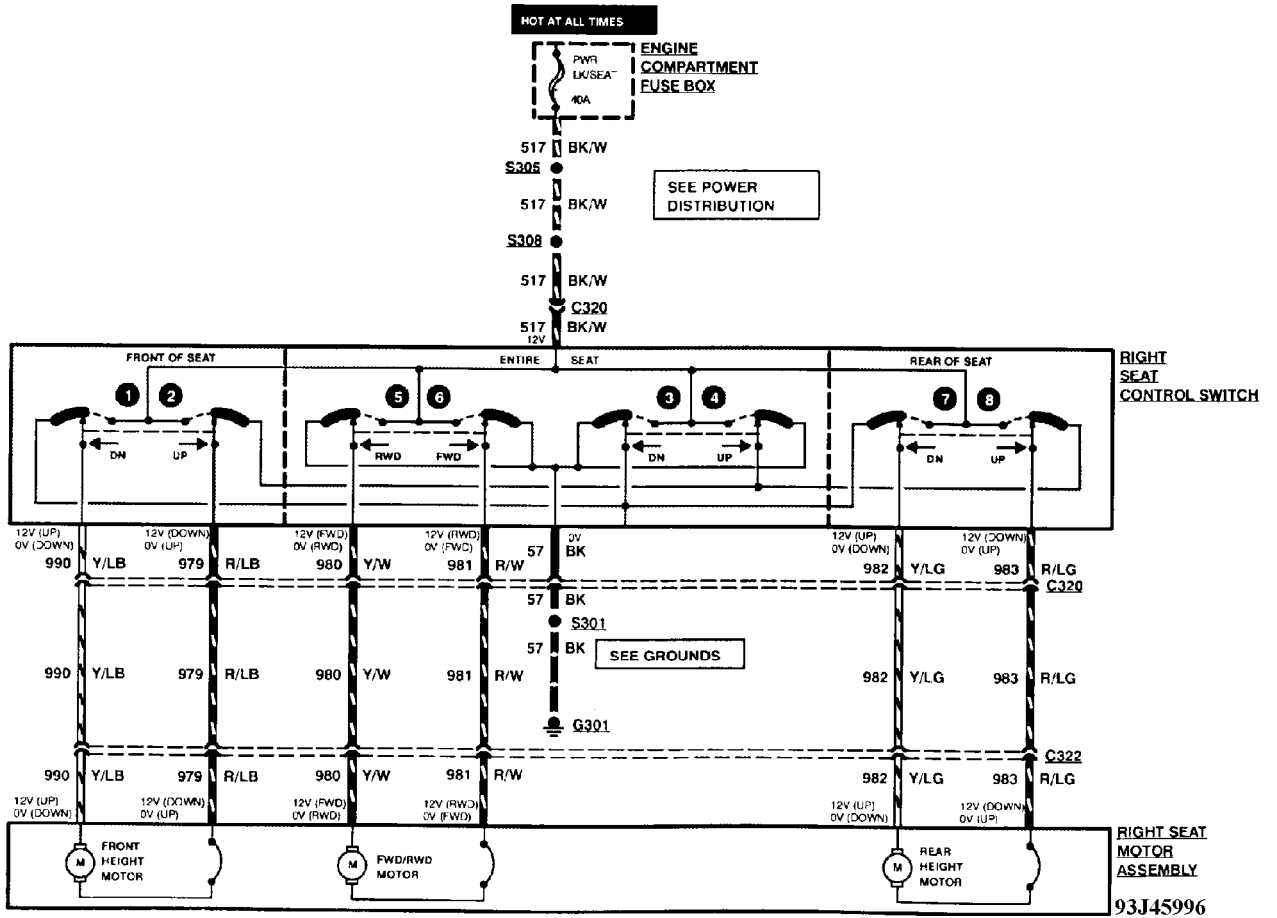

Fig. 79: Power Seats (1 Of 2)

WIRING DIAGRAMS

Selected Block (p. 3)

1993 Ford Taurus

For <http://www.mitchell.narod.ru/>

Copyright © 1997 Mitchell International

Friday, March 02, 2001 02:30PM

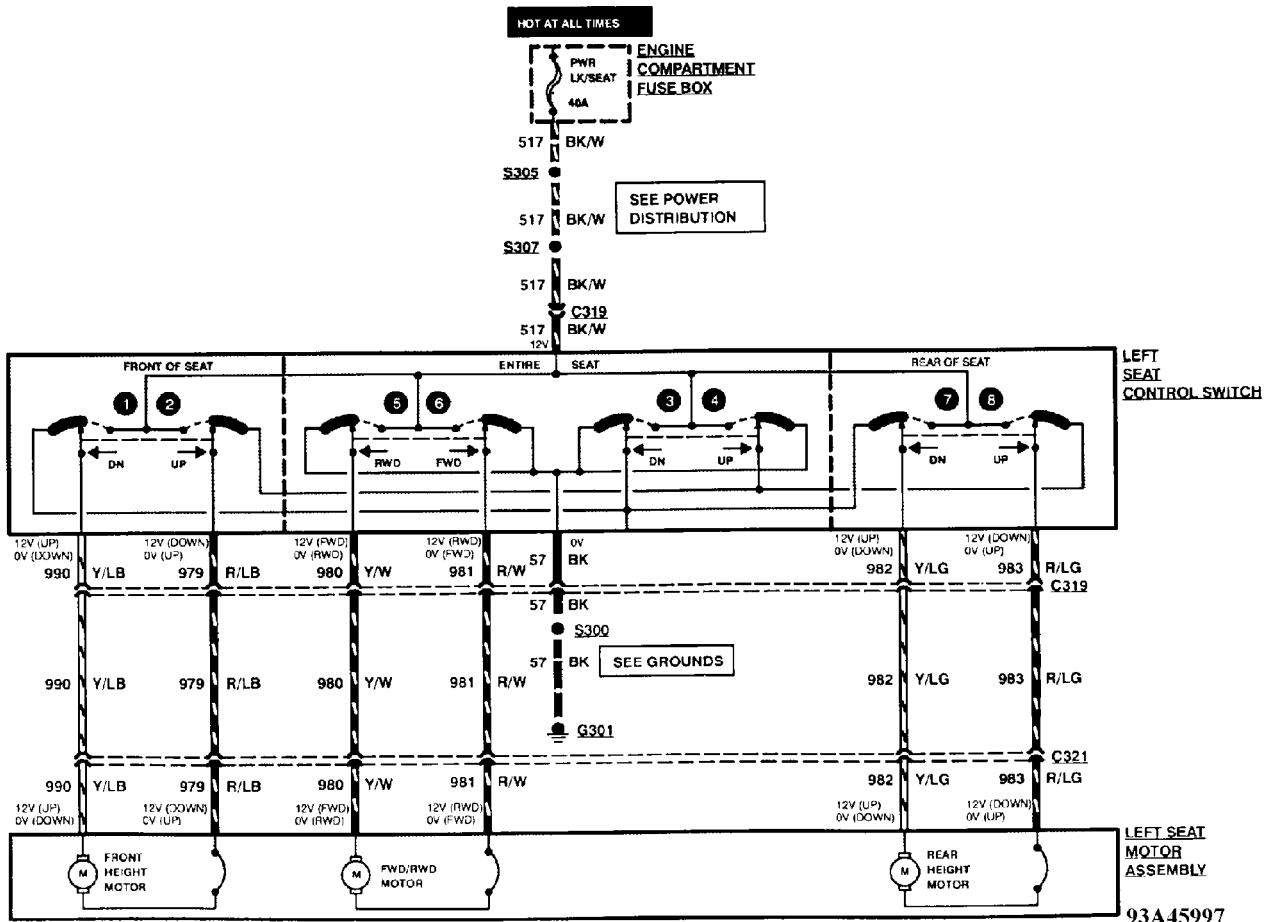

Fig. 80: Power Seats (2 Of 2)

93A45997

POWER TRUNK & FUEL FILLER DOORS

WIRING DIAGRAMS

Selected Block (p. 4)

1993 Ford Taurus

For <http://www.mitchell.narod.ru/>

Copyright © 1997 Mitchell International

Friday, March 02, 2001 02:30PM

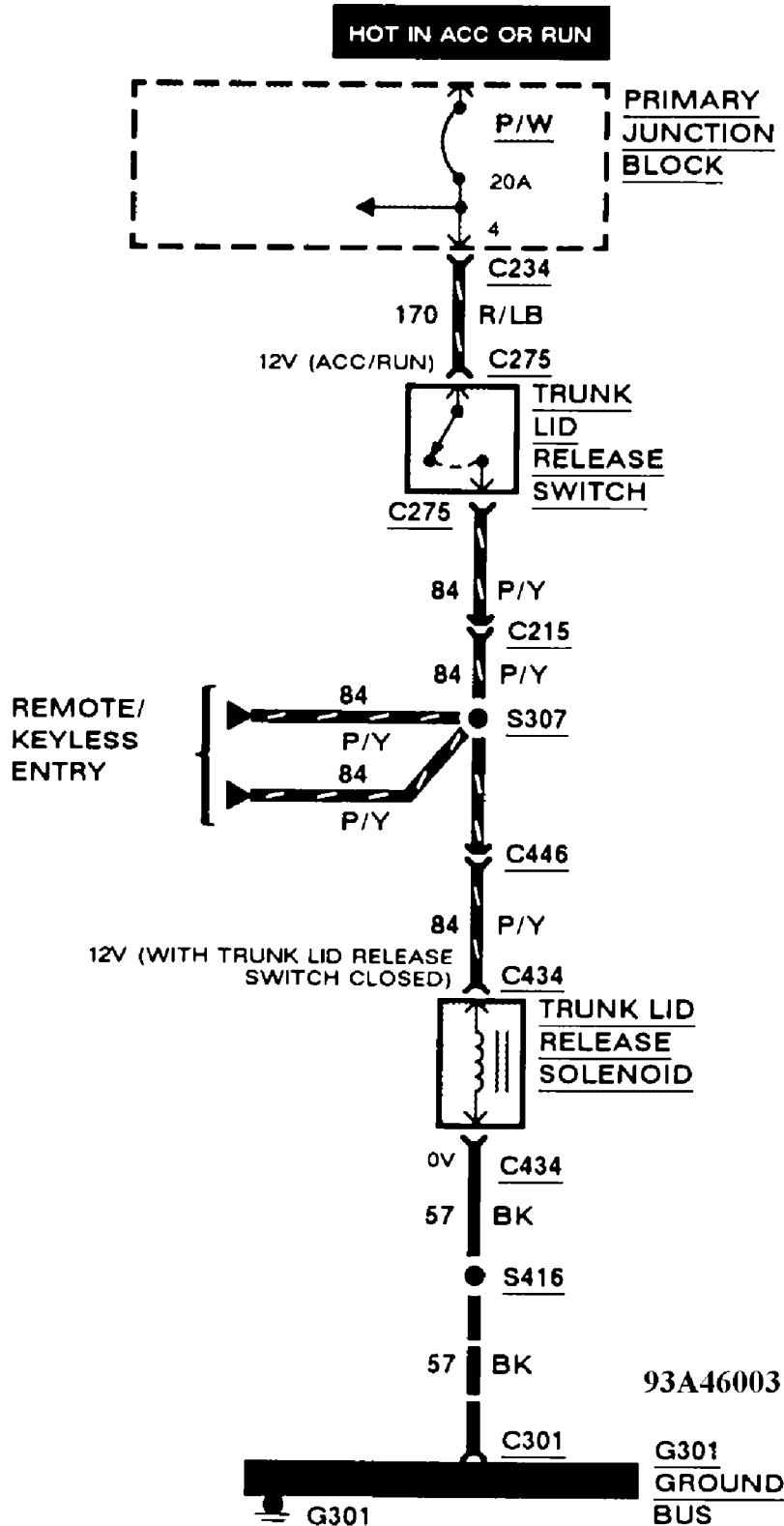

Fig. 81: Power Fuel Filler Door Release Wiring Diagram (1 Of 2)

WIRING DIAGRAMS

Selected Block (p. 5)

1993 Ford Taurus

For <http://www.mitchell.narod.ru/>

Copyright © 1997 Mitchell International

Friday, March 02, 2001 02:30PM

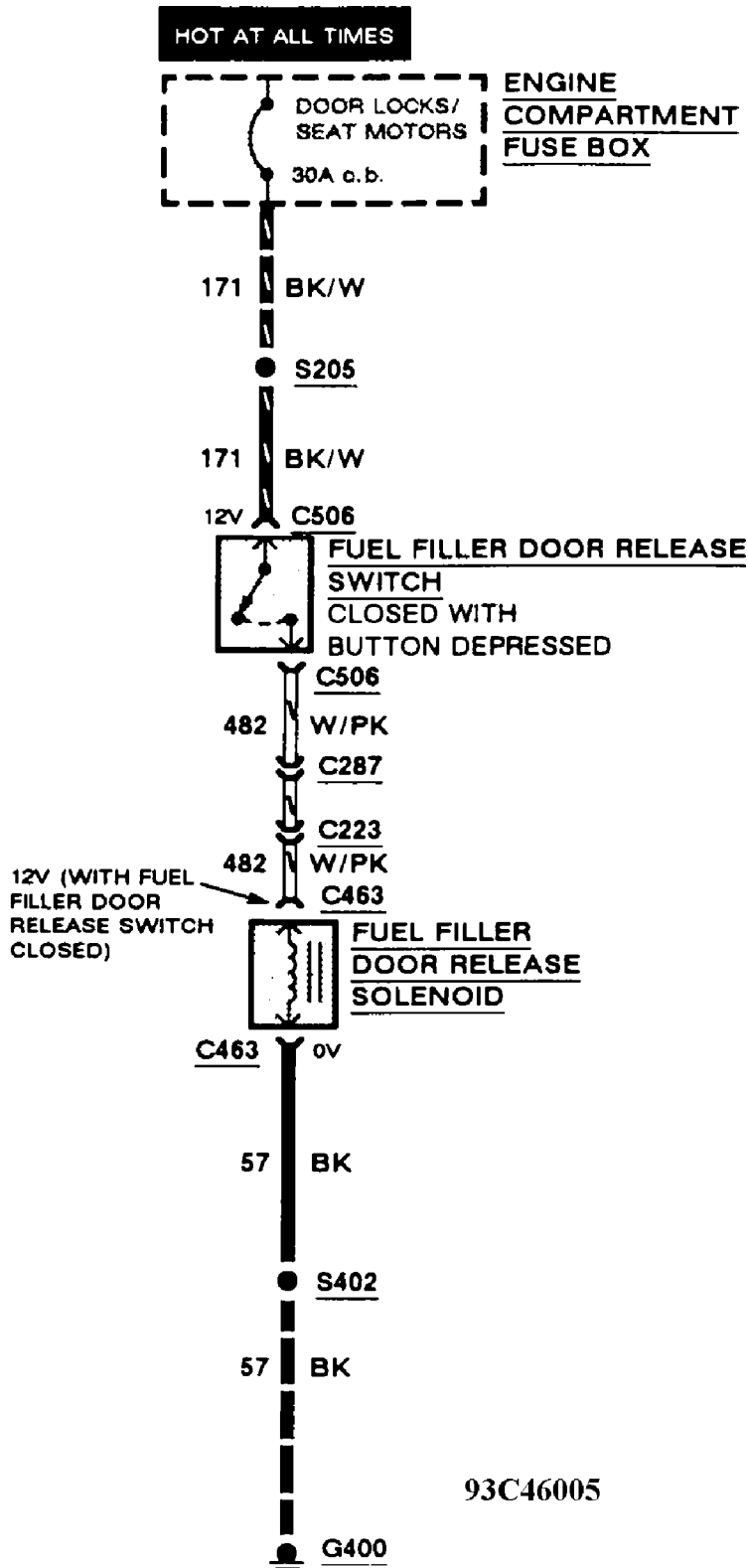

Fig. 82: Power Fuel Filler Door Release Wiring Diagram (2 Of 2)

WIRING DIAGRAMS

Selected Block (p. 6)

1993 Ford Taurus

For <http://www.mitchell.narod.ru/>

Copyright © 1997 Mitchell International

Friday, March 02, 2001 02:30PM

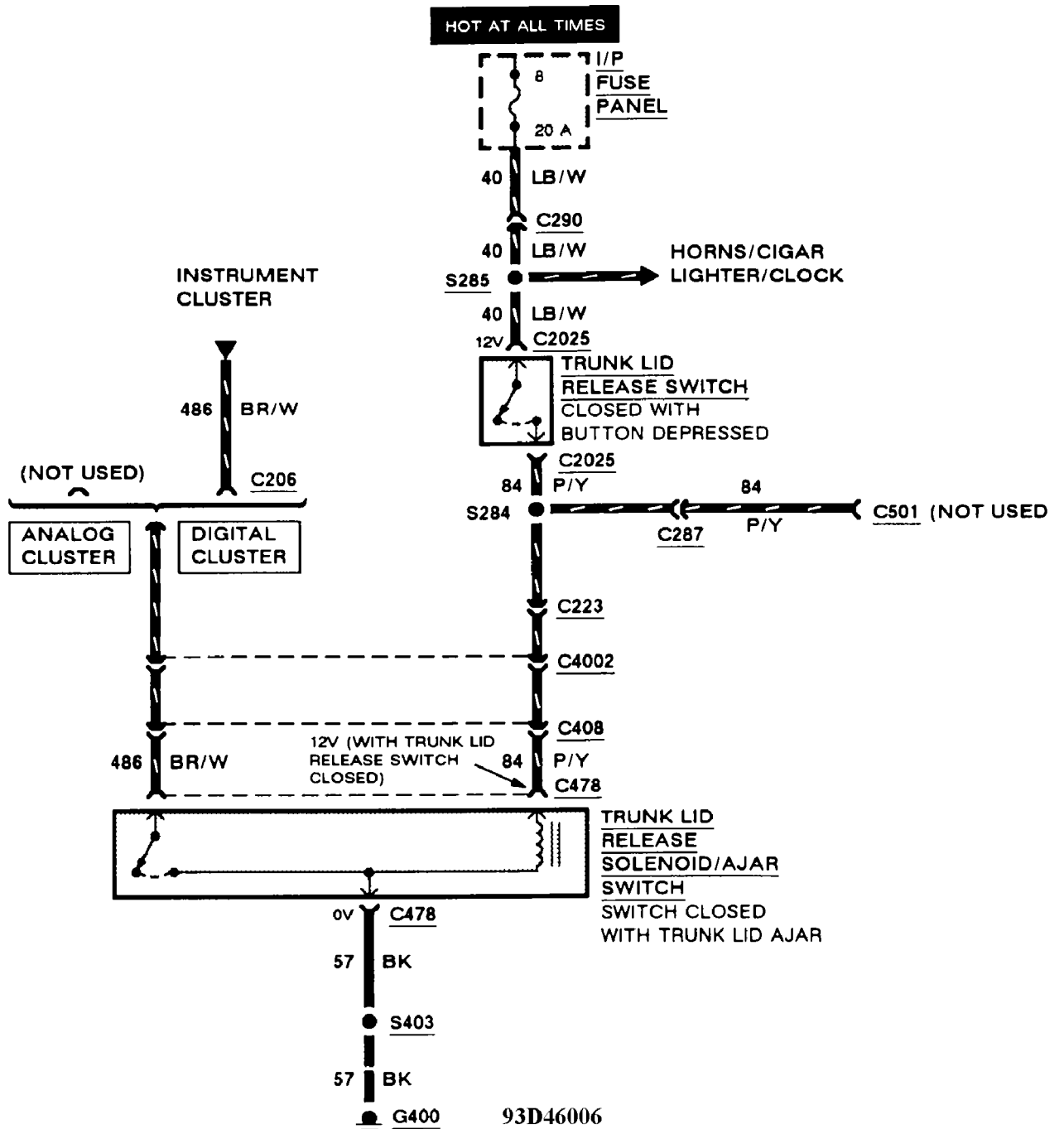

Fig. 83: Power Trunk Release W/ Police Package Wiring Diagram

WIRING DIAGRAMS

Selected Block (p. 7)

1993 Ford Taurus

For <http://www.mitchell.narod.ru/>

Copyright © 1997 Mitchell International

Friday, March 02, 2001 02:30PM

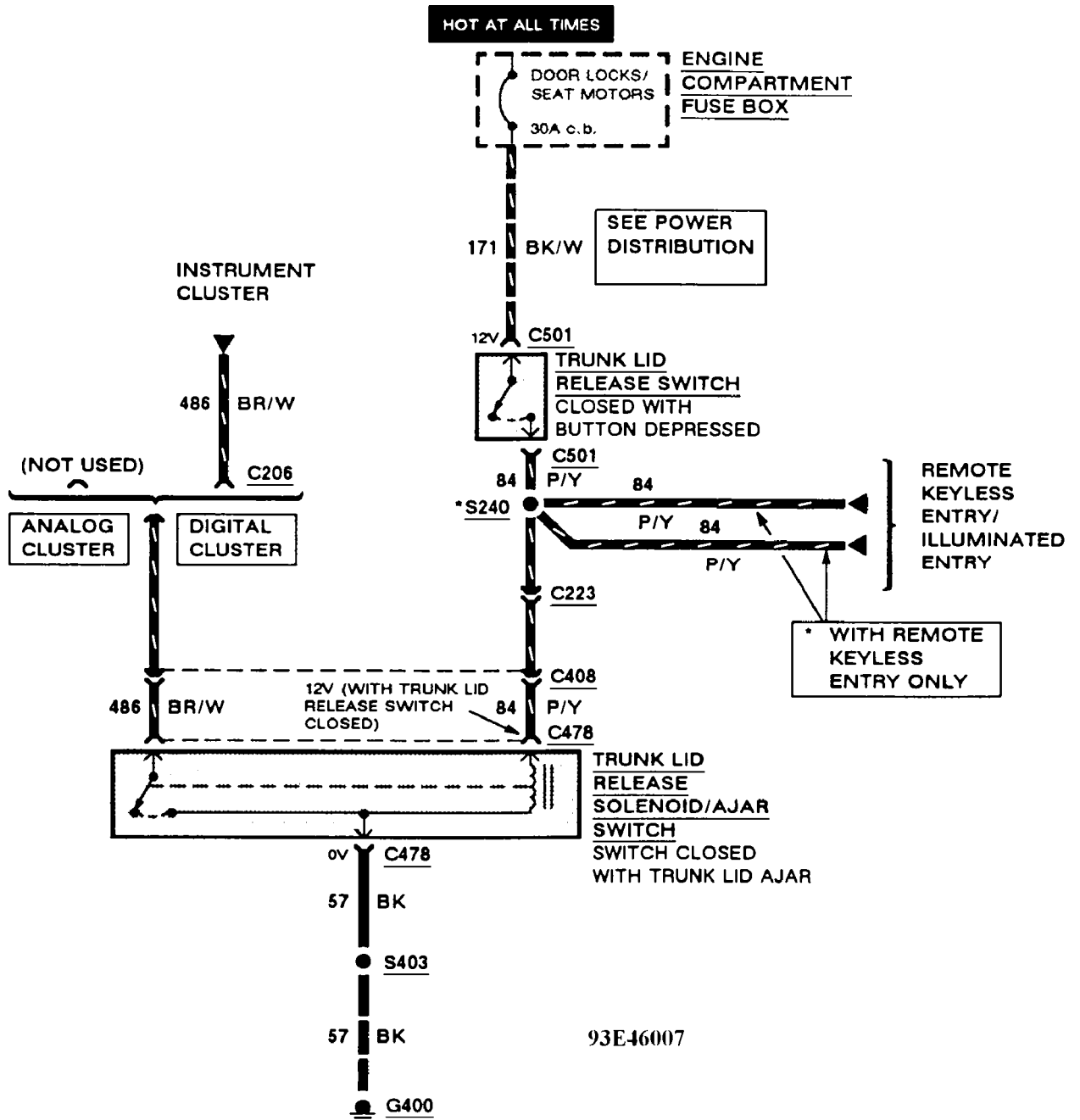

Fig. 84: Power Trunk Release W/O Police Package Wiring Diagram

WIRING DIAGRAMS

Selected Block (p. 8)

1993 Ford Taurus

For <http://www.mitchell.narod.ru/>

Copyright © 1997 Mitchell International

Friday, March 02, 2001 02:30PM

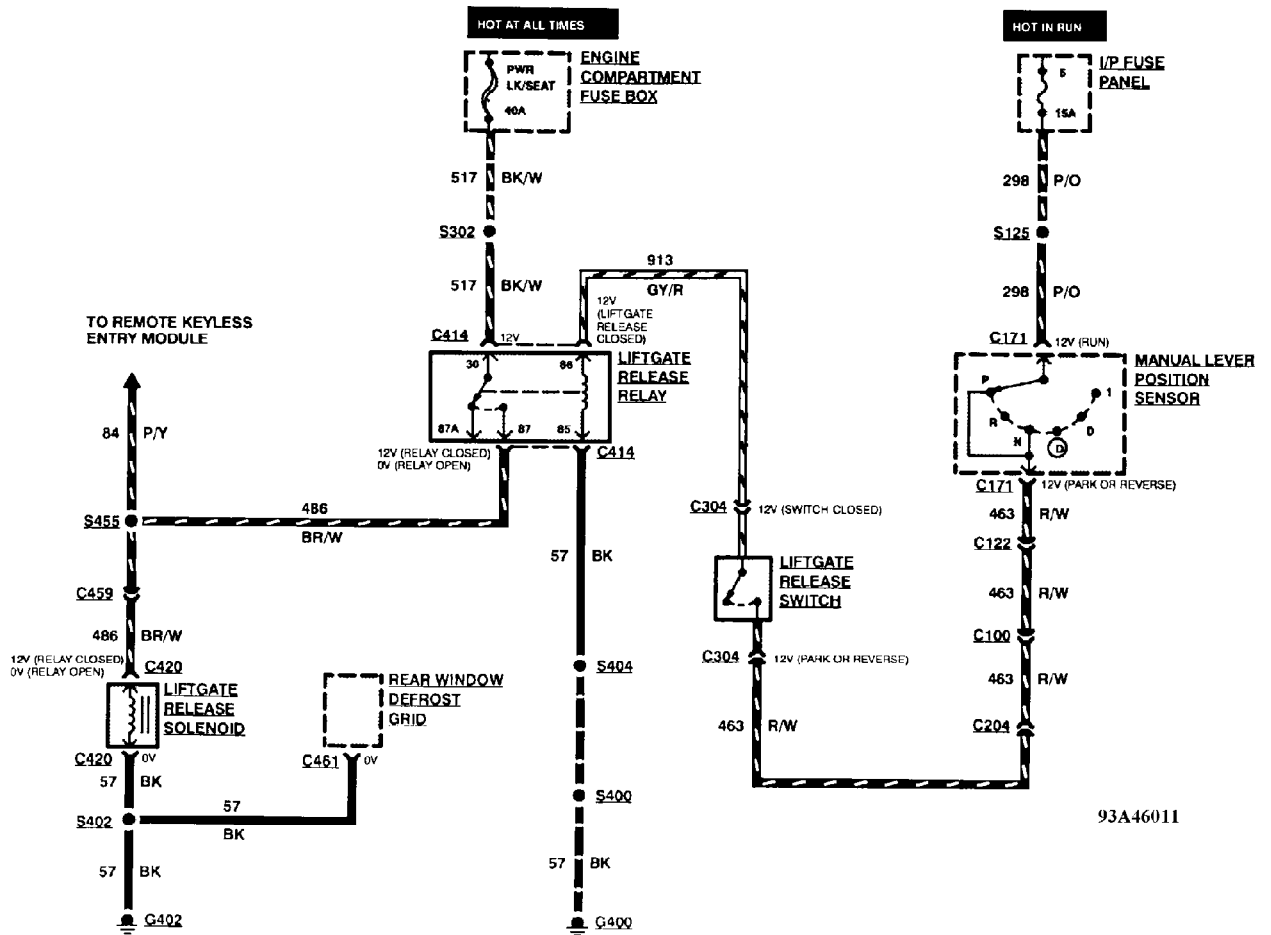

93A46011

Fig. 85: Power Liftgate Release Wiring Diagram

WIRING DIAGRAMS

Selected Block (p. 9)

1993 Ford Taurus

For <http://www.mitchell.narod.ru/>

Copyright © 1997 Mitchell International

Friday, March 02, 2001 02:30PM

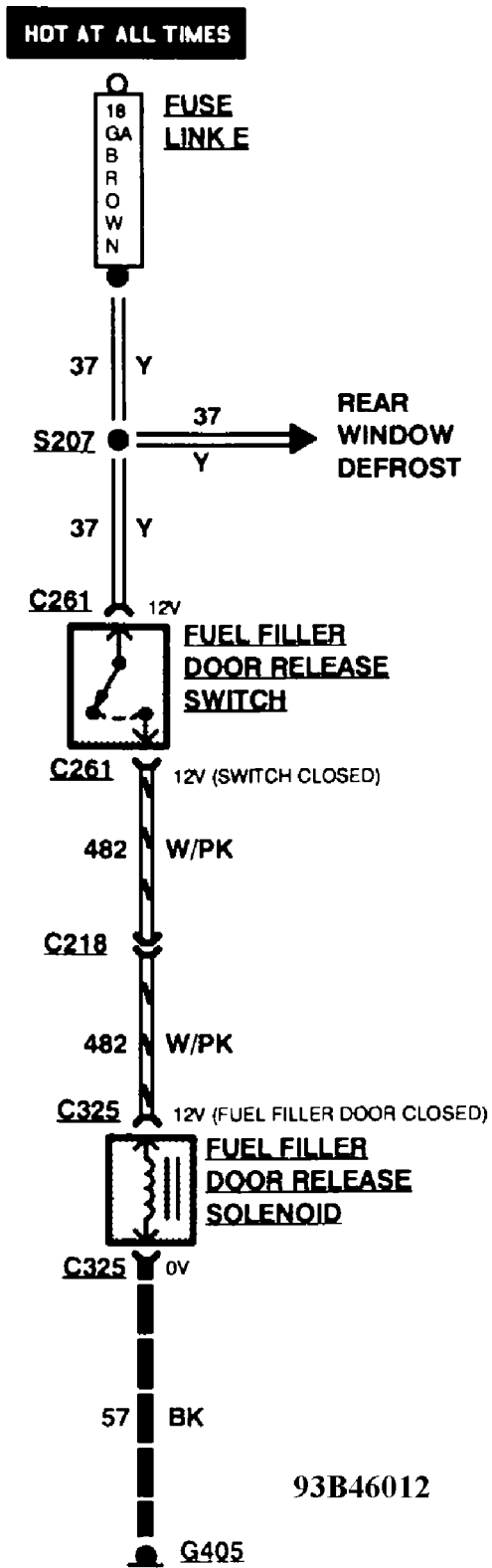

Fig. 86: Power Fuel Filler Door Release Wiring Diagram